

Dual torus fibrations and homological mirror symmetry for A_n -singularities

Kwokwai Chan and Kazushi Ueda

Abstract

We study homological mirror symmetry for not necessarily compactly supported coherent sheaves on the minimal resolutions of A_n -singularities. An emphasis is put on the relation with the Strominger-Yau-Zaslow conjecture.

1 Introduction

Let Y be the affine hypersurface

$$Y = \{(z, u, v) \in \mathbb{C}^\times \times \mathbb{C}^2 \mid uv = z^{-1}f(z)\}, \quad (1.1)$$

where $f(z) = (z - a_0)(z - a_1) \cdots (z - a_n)$ is a polynomial of degree $n + 1$ with mutually distinct positive real zeros $0 < a_0 < a_1 < \cdots < a_n$. We equip Y with the symplectic form

$$\omega = -\frac{\sqrt{-1}}{2} \left(\frac{dz \wedge d\bar{z}}{|z|^2} + du \wedge d\bar{u} + dv \wedge d\bar{v} \right) \Big|_Y.$$

The projection

$$\pi : Y \rightarrow \mathbb{C}^\times, \quad (z, u, v) \mapsto z \quad (1.2)$$

is a conic fibration whose discriminant is given by the zeros $\Delta = \{a_0, \dots, a_n\}$ of the polynomial f . Using this, one can show that the map

$$\rho : Y \rightarrow B, \quad (z, u, v) \mapsto \left(\log |z|, \frac{1}{2}(|u|^2 - |v|^2) \right) \quad (1.3)$$

is a Lagrangian torus fibration over the base $B = \mathbb{R}^2$, whose discriminant locus is given by

$$\Gamma := \{(s_0, 0), (s_1, 0), \dots, (s_n, 0)\},$$

where $s_i = \log a_i$ for $i = 0, \dots, n$. Each fiber L of this Lagrangian torus fibration is *special* in the sense that one has

$$\Im \left(e^{\sqrt{-1}\theta} \Omega \right) \Big|_L = 0$$

for some $\theta \in \mathbb{R}$, where

$$\Omega = \text{Res} \frac{dz \wedge du \wedge dv}{zuv - f(z)} = d \log z \wedge d \log u \quad (1.4)$$

is a nowhere-vanishing holomorphic 2-form on Y .

Strominger, Yau, and Zaslow [SYZ96] conjectured that any Calabi-Yau manifold admits a special Lagrangian torus fibration, and its mirror is obtained as the dual torus fibration. In this paper, we apply their ideas on the fibration (1.3), which we will refer to as the *SYZ fibration*.

Given the SYZ fibration $\rho : Y \rightarrow B$, one can equip the complement $B^{\text{sm}} := B \setminus \Gamma$ of the discriminant with two tropical affine structures. One is called the *symplectic affine structure*, and the other is called the *complex affine structure*. Here a manifold with a *tropical affine structure* is a manifold which is obtained by gluing open subsets of \mathbb{R}^m by the action of the affine linear group $\mathbb{R}^m \rtimes GL_m(\mathbb{Z})$ (or $\mathbb{R}^m \rtimes SL_m(\mathbb{Z})$ if the manifold is oriented). An *integral affine manifold* is the special case when the gluing maps belong to $\mathbb{Z}^m \rtimes GL_m(\mathbb{Z})$. The symplectic affine structure is defined by first taking a basis $\{\gamma_1, \gamma_2\}$ of the space of local sections of the relative homology bundle $(R^1\rho_*\mathbb{Z})^\vee$ and integrating the symplectic form ω along these cycles to obtain 1-forms on B ; $dx_i = \int_{\gamma_i} \omega$. Local affine coordinate on B^{sm} are primitives of these 1-forms. The complex affine structure is defined similarly by using $\Im(e^{\sqrt{-1}\theta}\Omega)$ instead of ω , and is *Legendre dual* to the symplectic affine structure [Hit01].

Following earlier works (cf. e.g. [Fuk05, KS06a, GS11, Aur07, Aur09, CLL12, AAK] and references therein), the mirror \check{Y} of Y is identified in [Cha13] with the complement of an anti-canonical divisor in the minimal resolution of the A_n -singularity. This mirror \check{Y} admits a special Lagrangian torus fibration, which is an *SYZ mirror* in the sense that the symplectic and complex affine structures are interchanged between Y and \check{Y} .

Let $E_1, \dots, E_n \subset \check{Y}$ be the irreducible components of the exceptional divisor in the minimal resolution. Then there is an isomorphism

$$\begin{array}{ccc} \text{deg} : \text{Pic } \check{Y} & \rightarrow & \mathbb{Z}^n \\ \Psi & & \Psi \\ \mathcal{L} & \mapsto & (\text{deg } \mathcal{L}|_{E_i})_{i=1}^n \end{array} \quad (1.5)$$

of abelian groups. We write the line bundle associated with $\mathbf{d} \in \mathbb{Z}^n$ as $\mathcal{L}_{\mathbf{d}}$.

Given an SYZ fibration, it is expected that Lagrangian sections of the original manifold and holomorphic line bundles on the mirror manifold are related by a kind of Fourier transform [AP01, LYZ00], which we refer to as the *SYZ transform*. We introduce the notion of a *strongly admissible path* in $\mathbb{C}^\times \setminus \Delta$, and associate an exact Lagrangian section $L_\gamma \subset Y$ of the SYZ fibration (1.3) to each strongly admissible path. The *winding number* $\mathbf{w}(\gamma) = (w_1(\gamma), \dots, w_n(\gamma)) \in \mathbb{Z}^n$ of a strongly admissible path is defined as the intersection numbers with the closed intervals $[a_{i-1}, a_i]$ for $i = 1, \dots, n$.

The first main result in this paper is the following:

Theorem 1.1. *For a strongly admissible path γ , the SYZ transform of the Lagrangian L_γ is given by the line bundle $\mathcal{L}_{-\mathbf{w}(\gamma)}$.*

Next we consider another symplectic manifold defined by

$$Y' = \left\{ (z, u, v) \in \mathbb{C}^\times \times \mathbb{C}^2 \mid uv = \frac{1}{z} + z^n \right\}. \quad (1.6)$$

Note that Y' is related to Y by moving a_i to the roots of unity, and hence is symplectomorphic to it. The map (1.3) gives a special Lagrangian torus fibration on Y' , whose discriminant consists only of the origin.

The mirror \check{Y} for Y' is the smooth stack obtained by removing an anti-canonical divisor from the total space \mathcal{K} of the canonical bundle of the weighted projective line $\mathbb{P}(1, n)$. Although the McKay correspondence [KV00] gives a derived equivalence

$$D^b \text{coh } \check{Y} \cong D^b \text{coh } \check{\mathcal{Y}}, \quad (1.7)$$

the Picard groups are *not* isomorphic:

$$\text{Pic } \check{\mathcal{Y}} \cong \text{Pic } \mathbb{P}(n, 1) \cong \mathbb{Z} \not\cong \mathbb{Z}^n \cong \text{Pic } \check{Y}.$$

Let $\mathcal{O}_{\check{\mathcal{Y}}}(i)$ be the line bundle on $\check{\mathcal{Y}}$ obtained by restricting the pull-back of $\mathcal{O}_{\mathbb{P}(1, n)}(i)$.

Homological mirror symmetry [Kon95, Kon98] for $\mathbb{P}(1, n)$ gives an equivalence

$$D^b \text{coh } \mathbb{P}(1, n) \cong D^b \mathfrak{Fuk} W, \quad (1.8)$$

where $\mathfrak{Fuk} W$ is a Fukaya category associated with the Lefschetz fibration

$$\begin{array}{ccc} W : \mathbb{C}^\times & \rightarrow & \mathbb{C} \\ \psi & & \psi \\ z & \mapsto & 1/z + z^n. \end{array}$$

This is a special case of (a generalization to toric stacks of) the work of Abouzaid [Abo06, Abo09] on homological mirror symmetry for toric varieties. There are also works by Fang [Fan08] and Fang, Liu, Treumann and Zaslow [FLTZ12, FLTZ11] on homological mirror symmetry for toric varieties, which are also motivated by the Strominger-Yau-Zaslow conjecture but different from the work of Abouzaid.

Under the equivalence (1.8), the collection $(\mathcal{O}_{\mathbb{P}(1, n)}(i))_{i=0}^n$ of line bundles is mapped to Lefschetz thimbles $(\Delta_i)_{i=0}^n$. These Lefschetz thimbles can be lifted to Lagrangian sections $(L_i)_{i=0}^n$ of the SYZ fibration for Y' . Let \mathcal{W}' be the full subcategory of the *wrapped Fukaya category* of Y' consisting of $(L_i)_{i=0}^n$.

The second main result in this paper is the following:

Theorem 1.2. *There is an equivalence*

$$D^b \mathcal{W}' \cong D^b \text{coh } \check{\mathcal{Y}} \quad (1.9)$$

of triangulated categories sending L_i to $\mathcal{O}_{\check{\mathcal{Y}}}(i)$ for $i = 0, \dots, n$.

The proof is based on an analysis of the behavior of the wrapped Fukaya category under suspension, and depends heavily on the work of Pascaleff [Pas]. We expect that $(L_i)_{i=0}^n$ generates the wrapped Fukaya category, so that the left hand side of (1.9) is the whole wrapped Fukaya category.

Theorems 1.1 and 1.2 are compatible in the following sense: There exists a symplectomorphism $Y \xrightarrow{\sim} Y'$ which induces an equivalence

$$D^b \mathcal{W} \xrightarrow{\sim} D^b \mathcal{W}',$$

so that the Lagrangians $(L_i)_{i=0}^n$ in Y' are images of Lagrangians $(L_{\gamma_i})_{i=0}^n$ in Y associated with certain strongly admissible paths $\gamma_0, \gamma_1, \dots, \gamma_n$ in $\mathbb{C}^\times \setminus \Delta$. One can then choose a derived equivalence

$$D^b \text{coh } \check{Y} \xrightarrow{\sim} D^b \text{coh } \check{Y}$$

in such a way that the images of $(L_{\gamma_i})_{i=0}^n$ under the composition

$$D^b \mathcal{W} \xrightarrow{\sim} D^b \mathcal{W}' \xrightarrow{\sim} D^b \text{coh } \check{Y} \xrightarrow{\sim} D^b \text{coh } \check{Y}$$

of equivalences are precisely given by their SYZ transforms described in Theorem 1.1. This shows that homological mirror symmetry for non-compact branes is realized by SYZ just as for compact branes [Cha13].

This paper is organized as follows: In Section 2, we briefly recall the SYZ construction of the mirror manifold \check{Y} from [Cha13, Section 3]. In Section 3, we introduce the notion of a strongly admissible path to which we associate a noncompact Lagrangian submanifold in (Y, ω) , which is a section of the SYZ fibration ρ . In Section 4, we describe holomorphic line bundles on \check{Y} obtained as SYZ transforms of noncompact Lagrangian submanifolds associated with strongly admissible paths and prove Theorem 1.1. The proof of Theorem 1.2 is given in Section 5.

Acknowledgment: K. C. is supported by Hong Kong RGC Direct Grant for Research 2011/2012 (Project ID: CUHK2060434). K. U. is supported by JSPS Grant-in-Aid for Young Scientists No.24740043. A part of this paper was worked out while K. U. was visiting the Chinese University of Hong Kong, whose hospitality is gratefully acknowledged.

2 SYZ mirror symmetry

We start with the Hamiltonian S^1 -action on (Y, ω) :

$$e^{2\pi\sqrt{-1}t} \cdot (u, v, z) = \left(e^{2\pi\sqrt{-1}t}u, e^{-2\pi\sqrt{-1}t}v, z \right),$$

whose moment map is given by

$$\mu(u, v, z) = \frac{1}{2} (|u|^2 - |v|^2).$$

Let $B := \mathbb{R}^2$. Then the map $\rho : Y \rightarrow B$ defined by

$$\rho(u, v, z) = (\log |z|, \mu) = \left(\log |z|, \frac{1}{2} (|u|^2 - |v|^2) \right)$$

is a Lagrangian torus fibration on Y , whose discriminant locus is given by the finite set

$$\Gamma := \{(s_0, 0), (s_1, 0), \dots, (s_n, 0)\} \subset B,$$

where we denote $s_i := \log a_i$ for $i = 0, \dots, n$. This is usually called an *SYZ fibration* of (Y, ω) .

Let $B^{\text{sm}} := B \setminus \Gamma$ be the smooth locus. Then the fiber $T_{s, \lambda}$ over a point $(s, \lambda) \in B^{\text{sm}}$ is a smooth Lagrangian torus in Y , and each of the fiber $T_{s_i, 0}$ over $(s_i, 0) \in \Gamma$ is singular with

one nodal singularity. Furthermore, the locus of Lagrangian torus fibers which bound nonconstant holomorphic disks is given by a union of vertical lines:

$$H := \{(s, \lambda) \in B \mid s = s_i \text{ for some } i = 0, 1, \dots, n\}.$$

Each connected component of H is called a *wall* in B .

The Lagrangian torus fibration $\rho : Y \rightarrow B$ induces an integral affine structure on B^{sm} , called the *symplectic affine structure*. As we have mentioned, integrality of the affine structure means that the transition maps between charts on B^{sm} are elements of the integral affine linear group

$$\text{Aff}(\mathbb{Z}^2) := \text{GL}_2(\mathbb{Z}) \rtimes \mathbb{Z}^2.$$

This ensures that $\Lambda \subset TB^{\text{sm}}$, the family of lattices locally generated by $\partial/\partial x_1, \partial/\partial x_2$ where x_1, x_2 are local affine coordinates on B^{sm} , is well-defined.

The Strominger-Yau-Zaslow (SYZ) conjecture [SYZ96] suggested that a mirror of (Y, ω) can be constructed by fiberwise-dualizing an SYZ fibration on (Y, ω) . More precisely, one defines the *semi-flat mirror* of (Y, ω) as the moduli space \check{Y}_0 of pairs $(T_{s, \lambda}, \nabla)$ where ∇ is a flat $U(1)$ -connection (up to gauge equivalence) on the trivial line bundle $\mathbb{C} := \mathbb{C} \times T_{s, \lambda}$ over a smooth Lagrangian torus fiber $T_{s, \lambda}$. Topologically, \check{Y}_0 is simply the quotient TB^{sm}/Λ of the tangent bundle TB^{sm} by Λ . This is naturally a complex manifold where the local complex coordinates are given by exponentiations of complexifications of local affine coordinates on B^{sm} (while the quotient $T^*B^{\text{sm}}/\Lambda^\vee$ of the cotangent bundle T^*B^{sm} by the dual lattice Λ^\vee , which is canonically a symplectic manifold, is contained in Y as an open dense subset such that the restriction of ω to it gives the canonical symplectic structure). However, this is not quite the correct mirror manifold because the natural complex structure on \check{Y}_0 is not globally defined due to nontrivial monodromy of the affine structure around each singular point $(s_i, 0) \in \Gamma$.

A more concrete description of this phenomenon is as follows. For $i = 0, 1, \dots, n$, consider the strip $B_i := (s_{i-1}, s_{i+1}) \times \mathbb{R}$ (where we set $s_{-1} := -\infty$ and $s_{n+1} := +\infty$). A covering of B^{sm} is given by the open sets

$$U_i := B_i \setminus [s_i, s_{i+1}) \times \{0\}, \quad V_i := B_i \setminus (s_{i-1}, s_i] \times \{0\}.$$

$i = 0, 1, \dots, n$. The intersection $U_i \cap V_i$ consists of two connected components:

$$U_i \cap V_i = B_i^+ \cup B_i^-,$$

where B_i^+ (resp. B_i^-) corresponds to the component in which $\lambda > 0$ (resp. $\lambda < 0$).

On U_i (resp. V_i), denote by u_i (resp. v_{i+1}) the exponentiation of the complexification of the left-pointing (resp. right-pointing) affine coordinate. (Our convention is that for a real number $x \in \mathbb{R}$, its complexification is given by $-x + \sqrt{-1}y$.) Also, denote by w the exponentiation of the complexification of the upward-pointing affine coordinate. See Figure 2.1.

Now w is a globally defined coordinate. Geometrically, it can be written as

$$w(T_{s, \lambda}, \nabla) = \begin{cases} \exp\left(-\int_\alpha \omega\right) \text{hol}_\nabla(\partial\alpha) & \text{for } \lambda \geq 0, \\ \exp\left(\int_\alpha \omega\right) \text{hol}_\nabla(-\partial\alpha) & \text{for } \lambda \leq 0, \end{cases}$$

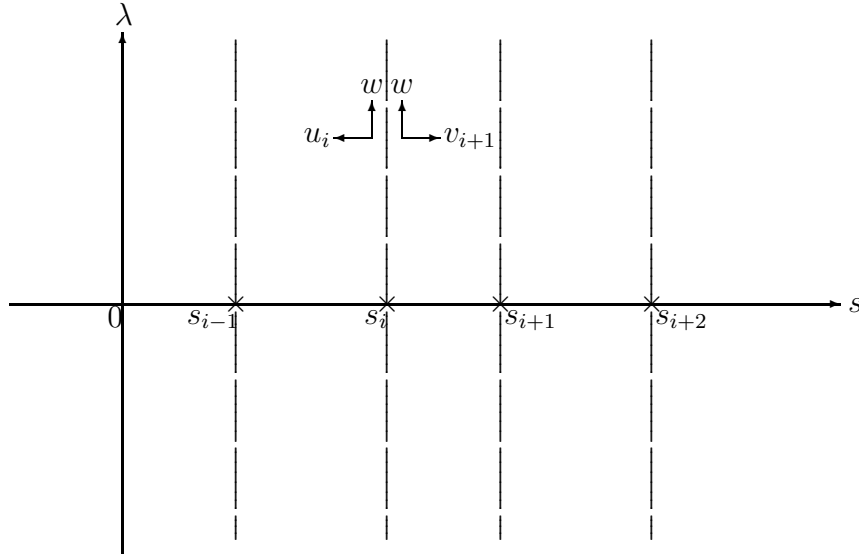

Figure 2.1: The base affine manifold B .

where $\alpha \in \pi_2(Y, T_{s_i, \lambda})$ is the class of the holomorphic disk in Y bounded by $T_{s_i, \lambda}$ for some $i = 0, 1, \dots, n$, and $\text{hol}_{\nabla}(\partial\alpha)$ is the holonomy of the flat $U(1)$ -connection ∇ around the boundary $\partial\alpha \in \pi_1(T_{s_i, \lambda})$. The class α changes to $-\alpha$ when one moves from $\lambda > 0$ to $\lambda < 0$.

But the other coordinates u_i and v_{i+1} are not globally defined: Since the monodromy of the affine structure going counter-clockwise around $(s_i, 0) \in \Gamma$ is given by the matrix

$$\begin{pmatrix} 1 & 1 \\ 0 & 1 \end{pmatrix},$$

the coordinates (u_i, w) and (v_{i+1}, w) glue on $U_i \cap V_i$ according to

$$\begin{aligned} u_i &= v_{i+1}^{-1} && \text{on } B_i^+, \\ u_i &= v_{i+1}^{-1} w && \text{on } B_i^-. \end{aligned}$$

Hence, the monodromy of the complex coordinates going counter-clockwise around the point $(s_i, 0)$ is nontrivial and given by

$$u_i \mapsto u_i w, \quad v_{i+1}^{-1} \mapsto v_{i+1}^{-1} w.$$

In particular, these complex coordinates on TB_i/Λ do not form a globally defined complex structure on \check{Y}_0 .

The examples in [Aur07, Aur09, CLL12, AAK] suggest the following construction (we should mention that these are all special cases of the constructions in Kontsevich-Soibelman [KS06b] and Gross-Siebert [GS11], but those general constructions largely ignore the symplectic aspects and hence Lagrangian torus fibration structures - they build the mirror family directly from tropical data in the base B): in order to get the genuine mirror manifold, we need to modify the gluing of complex charts on Y_0 by quantum corrections from disk instantons

$$u_i = v_{i+1}^{-1} + v_{i+1}^{-1} w = v_{i+1}^{-1} (1 + w) \quad \text{on } B_i^+, \quad (2.1)$$

$$u_i = v_{i+1}^{-1} w + v_{i+1}^{-1} = v_{i+1}^{-1} w (1 + w^{-1}) \quad \text{on } B_i^-. \quad (2.2)$$

Geometrically, the term $v_{i+1}^{-1}w$ in the first formula (2.1) should be viewed as multiplying v_{i+1}^{-1} by w where w corresponds to the unique nonconstant holomorphic disk bounded by the Lagrangian torus $T_{0,\lambda}$ whose area is given by

$$\lambda = -\log |w| > 0.$$

This means that we are correcting the term v_{i+1}^{-1} by adding the contribution from the holomorphic disk bounded by $T_{0,\lambda}$ when we cross the upper half of the wall $\{s_i\} \times \mathbb{R} \subset H$. In the same way, the term v_{i+1}^{-1} in the second formula (2.2) is given by multiplying $v_{i+1}^{-1}w$ by w^{-1} where w^{-1} now corresponds to the unique nonconstant holomorphic disk bounded by the Lagrangian torus $T_{0,\lambda}$ whose area is equal to

$$-\lambda = \log |w| = -\log |w^{-1}| > 0.$$

So we are correcting $v_{i+1}^{-1}w$ by the disk bounded by $T_{0,\lambda}$ when we cross the lower half of the wall $\{s_i\} \times \mathbb{R} \subset H$.

The formulas (2.1), (2.2) can actually be interpreted as wall-crossing formulas for the counting of Maslov index two holomorphic disks in Y bounded by Lagrangian torus fibers. To see this, we need to partially compactify Y by allowing z to take values in \mathbb{C} and replacing ρ by the map

$$(u, v, z) \mapsto (|z|, \mu) = \left(|z|, \frac{1}{2} (|u|^2 - |v|^2) \right).$$

Then the base becomes an affine manifold with both singularities and boundary: it is a right half-space \bar{B} in \mathbb{R}^2 , and the boundary $\partial\bar{B}$ corresponds to the divisor in Y defined by $z = 0$. In this situation, each of the local coordinates u_i , v_{i+1}^{-1} and $v_{i+1}^{-1}w$ can be expressed as in the form

$$\exp\left(-\int_{\beta} \omega\right) \text{hol}_{\nabla}(\partial\beta),$$

for a suitable relative homotopy class $\beta \in \pi_2(Y, T_{s,\lambda})$ of Maslov index two (cf. Auroux [Aur07, Aur09]).

In any case, the modification of gluing cancels the monodromy and defines global complex coordinates u_i, v_i, w on TB_i/Λ (topologically, $TB_i/\Lambda \cong (\mathbb{C}^\times)^2$) related by

$$u_i = v_i^{-1}, \quad u_{i+1} = v_{i+1}^{-1} \text{ and } u_i v_{i+1} = 1 + w. \quad (2.3)$$

The instanton-corrected mirror \check{Y} is then obtained by gluing together the pieces TB_i/Λ ($i = 0, 1, \dots, n$) according to (2.3). On the intersection $(TB_{i-1}/\Lambda) \cap (TB_i/\Lambda)$, we have

$$u_i = v_i^{-1}, \quad u_i v_{i+1} = 1 + w = u_{i-1} v_i.$$

We remark that, by our definition, the mirror manifold \check{Y} will have ‘‘gaps’’ because for instance u, v, w are \mathbb{C}^\times -valued. A natural way to ‘‘complete’’ the mirror manifold and fill out its gaps is by rescaling the symplectic structure of Y and performing analytic continuation; see [Aur07, Section 4.2] for a discussion of this ‘‘renormalization’’ process.

Finally, one observes that this is precisely the gluing of complex charts in the toric resolution $X \rightarrow \mathbb{C}^2/\mathbb{Z}_{n+1}$ of the A_n -singularity. We thus conclude that the mirror is precisely given by the complex manifold

$$\check{Y} := X \setminus D,$$

where $X = X_\Sigma$ is the toric surface defined by the 2-dimensional fan $\Sigma \in \mathbb{R}^2$ generated by

$$\{v_i := (i-1, 1) \in N \mid i = 0, 1, \dots, n+1\},$$

and D is the hypersurface in X_Σ defined by $h := \chi^{(0,1)} = 1$. Here $h : X \rightarrow \mathbb{C}$ is the holomorphic function whose zero locus is the union of all the toric divisors in X . For $i = 1, \dots, n$, if we let S_i denote the interval $(s_{i-1}, s_i) \times \{0\} \subset B$, then (the closure of) the quotient $TS_i/TS_i \cap \Lambda$ in \check{Y} is one of the n exceptional divisors in X_Σ , each of which is a (-2) -curve. We denote this exceptional divisor by $E_i \subset \check{Y}$.

Let $M = \text{Hom}(N, \mathbb{Z})$ be the lattice of characters of the dense torus of X_Σ and $\Sigma(1) = \{v_0, \dots, v_{n+1}\}$ be the set of one-dimensional cones of the fan Σ . If we write the toric divisor on X_Σ corresponding to $v_i \in \Sigma(1)$ as D_i , then we have $D_i = E_i$ for $i = 1, \dots, n$, and D_0 and D_{n+1} are non-compact divisors. One can easily show from the divisor sequence

$$0 \rightarrow M \rightarrow \mathbb{Z}^{\Sigma(1)} \rightarrow \text{Pic } X_\Sigma \rightarrow 0$$

that $\text{Pic } X_\Sigma$ is generated by $\mathcal{O}(D_i)$ for $i = 0, \dots, n-1$, and the map

$$\begin{array}{ccc} \text{deg} : \text{Pic } X_\Sigma & \rightarrow & \mathbb{Z}^n \\ \downarrow & & \downarrow \\ \mathcal{L} & \mapsto & (\text{deg } \mathcal{L}|_{D_i})_{i=1}^n \end{array}$$

is an isomorphism of abelian groups. Since $\check{Y} = X_\Sigma \setminus D$ is the complement of a principal divisor, the restriction map $\text{Pic } X_\Sigma \rightarrow \text{Pic } \check{Y}$ and hence the map (1.5) is an isomorphism of abelian groups.

3 Lagrangian submanifolds fibred over paths

Consider the projection map

$$\pi : Y \rightarrow \mathbb{C}^\times, \quad (u, v, z) \mapsto z.$$

Each fiber is a conic $\{(u, v) \in \mathbb{C}^2 \mid uv = z^{-1}f(z)\}$ which degenerates to the cone $uv = 0$ over a zero of the polynomial f . Recall that we denote by

$$\Delta = \{a_0, a_1, \dots, a_n\}$$

the set of zeros of the polynomial $f(z)$, which we have assumed to be real and positive, and in the ordering

$$0 < a_0 < a_1 < \dots < a_n.$$

The symplectic fibration $\pi : Y \rightarrow \mathbb{C}^\times$ induces a connection on the tangent bundle of Y where the horizontal subspace at $y \in Y_0$ is given by the symplectic orthogonal complement to the vertical subspace:

$$H_y := \text{Ker}(d\pi_y)^{\perp\omega}.$$

Given a smooth embedded path $\gamma : I \rightarrow \mathbb{C}^\times \setminus \Delta$ where $I \subset \mathbb{R}$ is an interval, parallel transport with respect to the above connection along γ yields symplectomorphisms between smooth fibers

$$\tau_{t_1}^{t_2} : \pi^{-1}(\gamma(t_1)) \rightarrow \pi^{-1}(\gamma(t_2)),$$

for $t_1 < t_2 \in I$. These symplectomorphisms are S^1 -equivariant since the S^1 -action is Hamiltonian. The vanishing cycle V_t in a smooth fiber $\pi^{-1}(\gamma(t))$ is given by its equator $\mu = 0$ (i.e. $|u| = |v|$). Vanishing cycles are invariant under parallel transport, so that the *Lefschetz thimble* L_γ along γ , given by the union of all vanishing cycles $V_t \subset \pi^{-1}(\gamma(t))$ for $t \in I$, is a Lagrangian submanifold in (Y, ω) . If γ is a matching path, i.e. a path connecting two critical values of π in \mathbb{C}^\times , then L_γ is a Lagrangian sphere in (Y, ω) .

Other Lagrangian submanifolds can be constructed in a similar way, as in the work of Pascaleff [Pas].

Definition 3.1. Let $\gamma : \mathbb{R} \rightarrow \mathbb{C}^\times \setminus \Delta$ be a smooth embedded path. We call the path γ *admissible* if the following conditions are satisfied:

- (1) (boundary conditions) $\lim_{t \rightarrow -\infty} |\gamma(t)| = 0$ and $\lim_{t \rightarrow \infty} |\gamma(t)| = \infty$.
- (2) γ intersects transversally with each of the line segments $\epsilon_i := [a_{i-1}, a_i]$ for $i = 1, \dots, n$.

Given an admissible path $\gamma : \mathbb{R} \rightarrow \mathbb{C}^\times$, we fix $t_0 \in \mathbb{R}$ and choose a Lagrangian cycle C_0 in the conic fiber $\pi^{-1}(\gamma(t_0))$. Then the submanifold L_{γ, C_0} contained inside $\pi^{-1}(\gamma)$ swept out by the parallel transport of C_0 along γ is a Lagrangian submanifold in (Y, ω) (cf. [Aur07, Section 5.1] and [Pas, Section 3.3]).

Definition 3.2. Let $\gamma : \mathbb{R} \rightarrow \mathbb{C}^\times \setminus \Delta$ be an admissible path. For $i = 1, \dots, n$, we define the *i -th winding number* $w_i(\gamma)$ of γ to be the topological intersection number between $\gamma(\mathbb{R})$ and the line segment $\epsilon_i = [a_{i-1}, a_i] \subset \mathbb{C}^\times$.

Notice that the winding numbers of γ are invariant when we deform γ in a fixed homotopy class relative to the boundary conditions $\lim_{t \rightarrow -\infty} |\gamma(t)| = 0$ and $\lim_{t \rightarrow \infty} |\gamma(t)| = \infty$. In particular, we can deform γ so that $\gamma(t)$ lies on the negative real axis for $t < -T$ for some fixed positive T . Then we consider the Lagrangian (real locus)

$$C_t := \{(u, v, z) \in \pi^{-1}(\gamma(t)) \mid u, v \in \mathbb{R}\}.$$

in the conic fiber $\pi^{-1}(\gamma(t))$ for each $t < -T$, which is ‘dual’ to the vanishing cycle V_t . Notice that C_t is invariant under symplectic parallel transport for all $t < -T$, meaning that

$$\tau_{t_1}^{t_2}(C_{t_1}) = C_{t_2}$$

for all $t_1 < t_2 < -T$. Let L_γ be the submanifold in Y swept out by parallel transport of C_t ($t < -T$):

$$L_\gamma := \bigcup_{t \in (-\infty, -T)} C_t \cup \bigcup_{t \in [-T, \infty)} \tau_{-T}^t(C_{-T}).$$

This defines a Lagrangian submanifold in (Y, ω) which is homeomorphic to \mathbb{R}^2 . Note that the curve $C_{-T} := \{(u, v, z) \in \pi^{-1}(\gamma(-T)) \mid u, v \in \mathbb{R}\}$ in the conic fiber $\pi^{-1}(\gamma(-T))$ is being twisted by Dehn twists in vanishing cycles (i.e. the equator $\lambda = 0$ in a fiber of $\pi : Y \rightarrow \mathbb{C}^\times$) as one goes along γ .

Furthermore, given an admissible path γ , we can deform it (again with respect to the boundary conditions $\lim_{t \rightarrow -\infty} |\gamma(t)| = 0$ and $\lim_{t \rightarrow \infty} |\gamma(t)| = \infty$) so that the following condition is satisfied:

Definition 3.3. An admissible path $\gamma : \mathbb{R} \rightarrow \mathbb{C}^\times \setminus \Delta$ is *strongly admissible* if the modulus $|\gamma| : \mathbb{R} \rightarrow \mathbb{R}^{>0}$ is strictly increasing.

Proposition 3.4. Let $\gamma : \mathbb{R} \rightarrow \mathbb{C}^\times$ be a strongly admissible path. Then the Lagrangian submanifold L_γ is a section of the SYZ fibration $\rho : Y \rightarrow B$.

Proof. By definition, L_γ is invariant under parallel transport, so it is a Lagrangian submanifold in (Y, ω) . Moreover, it is clear that the moment map μ when restricted to C_t for $t < -T$ is a one-to-one map. Since the symplectomorphisms τ_{-T}^t are all S^1 -equivariant, the value of μ is preserved under parallel transport. Thus the restriction of μ to $\tau_{-T}^t(C_{-T})$ remains a one-to-one map. Together with the condition that $|\gamma(t)|$ is strictly increasing, this implies that L_γ intersects each fiber $T_{s,\lambda}$ of the SYZ fibration $\rho : Y \rightarrow B$ at one point. Hence L_γ is a section of $\rho : Y \rightarrow B$. \square

By deforming γ in a fixed homotopy class if necessary, one can furthermore assume that a strongly admissible path $\gamma : \mathbb{R} \rightarrow \mathbb{C}^\times \setminus \Delta$ satisfies $|\gamma(s)| = e^s$ for any $s \in \mathbb{R}$ and $\gamma(s_i) = -a_i$ for $i = 0, \dots, n$ (recall that $s_i = \log a_i$ for each i). Then there exists a unique lift $\tilde{\gamma} : \mathbb{R} \rightarrow \mathbb{R}$ of $\gamma/|\gamma| : \mathbb{R} \rightarrow S^1$ such that $\tilde{\gamma}(s_0) = 0$, and the winding numbers of γ can be computed as

$$w_i(\gamma) = \frac{1}{2\pi} (\tilde{\gamma}(s_i) - \tilde{\gamma}(s_{i-1}))$$

for $i = 1, \dots, n$.

As an example, consider the path

$$\gamma_0 : \mathbb{R} \rightarrow \mathbb{C}^\times, \quad t \mapsto -e^t,$$

which is clearly strongly admissible. The corresponding Lagrangian submanifold $L_0 := L_{\gamma_0}$ is simply the Cartesian product of the real locus C_{s_0} inside the conic fiber $C_{s_0} = \pi^{-1}(-a_0)$ with the negative real axis (which is the image $\gamma_0(\mathbb{R})$ of the path). As a section of the SYZ fibration $\rho : Y \rightarrow B$, the Lagrangian L_0 can be explicitly written as

$$\sigma : B \rightarrow Y, \quad (s, \lambda) \mapsto (u(s, \lambda), v(s, \lambda), z(s, \lambda)),$$

where

$$\begin{aligned} u(s, \lambda) &= \sqrt{\sqrt{\lambda^2 + |f(-e^s)|^2} + \lambda}, \\ v(s, \lambda) &= (-1)^{n-1} \sqrt{\sqrt{\lambda^2 + |f(-e^s)|^2} - \lambda}, \\ z(s, \lambda) &= -e^s. \end{aligned}$$

4 SYZ transforms

Consider $\Lambda^\vee \subset T^*B^{\text{sm}}$, the family of lattices locally generated by dx_1, dx_2 . As before, x_1, x_2 here denote local affine coordinates on B^{sm} . As in [Cha13], we will assume that $x_2 = -\lambda$ is the globally defined coordinate. Let

$$\omega_0 := dx_1 \wedge d\xi_1 + dx_2 \wedge d\xi_2$$

be the canonical symplectic structure on the quotient $T^*B^{\text{sm}}/\Lambda^\vee$ of the cotangent bundle T^*B^{sm} by Λ^\vee , where (ξ_1, ξ_2) are fiber coordinates on T^*B^{sm} so that $(x_1, x_2, \xi_1, \xi_2) \in T^*B^{\text{sm}}$ denotes the cotangent vector $\xi_1 dx_1 + \xi_2 dx_2$ at the point $(x_1, x_2) \in B^{\text{sm}}$. In the previous section, we have constructed a global Lagrangian section L_0 of the SYZ fibration $\rho : Y \rightarrow B$. Then a theorem of Duistermaat [Dui80] says that there exists a fiber-preserving symplectomorphism

$$\Theta : (T^*B^{\text{sm}}/\Lambda^\vee, \omega_0) \xrightarrow{\cong} (\rho^{-1}(B^{\text{sm}}), \omega)$$

so that L_0 corresponds to the zero section of $T^*B^{\text{sm}}/\Lambda^\vee$.

This symplectomorphism can be constructed as follows. Let $b \in B^{\text{sm}}$. Then for every $\alpha \in T_b^*B^{\text{sm}}$, we can associate a vector field v_α on the fiber $\rho^{-1}(b)$ by

$$\iota_{v_\alpha} \omega = \rho^* \alpha.$$

Let ϕ_α^τ be the flow of v_α at time $\tau \in \mathbb{R}$. Then we define an action θ_α of α on $\rho^{-1}(b)$ by the time-1 flow

$$\theta_\alpha(y) = \phi_\alpha^1(y), \quad y \in \rho^{-1}(b).$$

Now the covering map

$$T^*B^{\text{sm}} \rightarrow \rho^{-1}(B^{\text{sm}}), \quad \alpha \mapsto \theta_\alpha(\sigma(\text{pr}(\alpha))),$$

where $\text{pr} : T^*B^{\text{sm}} \rightarrow B^{\text{sm}}$ denotes the projection map, induces a symplectomorphism $\Theta : T^*B^{\text{sm}}/\Lambda^\vee \rightarrow \rho^{-1}(B^{\text{sm}})$.

Now let y_1, y_2 be the fiber coordinates on TB^{sm} dual to ξ_1, ξ_2 , i.e. $(x_1, x_2, y_1, y_2) \in TB^{\text{sm}}$ denotes the tangent vector $y_1 \partial/\partial x_1 + y_2 \partial/\partial x_2$ at the point $(x_1, x_2) \in B^{\text{sm}}$. Given a strongly admissible path $\gamma : \mathbb{R} \rightarrow \mathbb{C}^\times$, the noncompact Lagrangian submanifold L_γ is a section of the SYZ fibration $\rho : Y \rightarrow B$ by Proposition 3.4 (and as we mentioned before, every admissible path can be deformed to a strongly admissible one). Via the symplectomorphism Θ , we can write L_γ in the form

$$L_\gamma = \{(x_1, x_2, \xi_1, \xi_2) \in T^*B^{\text{sm}}/\Lambda^\vee \mid (x_1, x_2) \in B^{\text{sm}}, \xi_j = \xi_j(x_1, x_2) \text{ for } j = 1, 2\},$$

where $\xi_j = \xi_j(x_1, x_2)$, $j = 1, 2$, are smooth functions on B^{sm} . Since L_γ is Lagrangian, the functions ξ_1, ξ_2 satisfy

$$\frac{\partial \xi_j}{\partial x_l} = \frac{\partial \xi_l}{\partial x_j}$$

for $j, l = 1, 2$ (see [LYZ00, AP01, Cha13]).

Lying at the basis of the SYZ proposal [SYZ96] is the fact that the dual T^* of a torus T can be viewed as the moduli space of flat $U(1)$ -connections on the trivial line bundle $\underline{\mathbb{C}} := \mathbb{C} \times T$ over T . So a Lagrangian section $L = \{(x, \xi(x)) \in T^*U/T^*U \cap \Lambda^\vee \mid x \in U\}$ over an open set $U \subset B^{\text{sm}}$ corresponds to a family of connections $\{\nabla_{\xi(x)} \mid x \in U\}$ patching together to give a $U(1)$ -connection which can locally be written as

$$\check{\nabla}_U = d + 2\pi\sqrt{-1}(\xi_1 dy_1 + \xi_2 dy_2)$$

over $TU/TU \cap \Lambda \subset \check{Y}$. As shown in [LYZ00, AP01] (see also [Cha13, Section 2]), the $(0, 2)$ -part $F^{(0,2)}$ (and also $(2, 0)$ -part $F^{(2,0)}$) of the curvature two form of $\check{\nabla}_U$ is trivial.

Recall that a covering of B^{sm} is given by the open sets

$$U_i := B_i \setminus [s_i, s_{i+1}) \times \{0\}, \quad V_i := B_i \setminus (s_{i-1}, s_i] \times \{0\}.$$

for $i = 0, 1, \dots, n$. Now, the restriction of the Lagrangian section L_γ to each U_i (resp. V_i) is transformed to a $U(1)$ -connection $\check{\nabla}_{U_i}$ over $TU_i/TU_i \cap \Lambda$ (resp. $\check{\nabla}_{V_i}$ over $TV_i/TV_i \cap \Lambda$). These connections can be glued together according to the gluing formulas (2.1), (2.2). Since the $(0, 2)$ -part $F^{(0,2)}$ of the curvature two form vanishes, this defines a holomorphic line bundle \mathcal{L}_γ over \check{Y} .

Definition 4.1. Let $\gamma : \mathbb{R} \rightarrow \mathbb{C}^\times$ be a strongly admissible path and L_γ be the noncompact Lagrangian submanifold in (Y, ω) associated to γ . We define the SYZ transform of L_γ to be the holomorphic line bundle \mathcal{L}_γ over \check{Y} , i.e.

$$\mathcal{F}(L_\gamma) := \mathcal{L}_\gamma.$$

Notice that the isomorphism class of \mathcal{L}_γ is unchanged when we deform L_γ in a fixed Hamiltonian isotopy class (or deforming γ is a fixed homotopy class relative to the boundary conditions $\lim_{t \rightarrow -\infty} |\gamma(t)| = 0$ and $\lim_{t \rightarrow \infty} |\gamma(t)| = \infty$). Henceforth, we will regard this as defining the SYZ transform of the Hamiltonian isotopy class of the Lagrangian submanifold $L_\gamma \subset Y$ as an isomorphism class of holomorphic line bundle over \check{Y} .

As an immediate example, the SYZ transform of the zero section $L_0 = L_{\gamma_0}$ gives the structure sheaf $\mathcal{O}_{\check{Y}}$ over \check{Y} .

The main goal of this section is to compute (the isomorphism class of) the line bundle \mathcal{L}_γ in terms of the winding numbers of the path γ . To begin with, note that the isomorphism class of a line bundle over \check{Y} is determined by the degrees of its restrictions to the exceptional divisors E_i for $i = 1, \dots, n$. Given integers $d_1, \dots, d_n \in \mathbb{Z}$, let us denote by $\mathcal{L}_{d_1, \dots, d_n}$ the line bundle on \check{Y} such that $\deg \mathcal{L}_{d_1, \dots, d_n}|_{E_i} = d_i$.

Now, given a Lagrangian section

$$L_\gamma = \{(x_1, x_2, \xi_1, \xi_2) \in T^*B^{\text{sm}}/\Lambda^\vee \mid (x_1, x_2) \in B^{\text{sm}}, \xi_j = \xi_j(x_1, x_2) \text{ for } j = 1, 2\},$$

of the SYZ fibration $\rho : Y \rightarrow B$, its SYZ transform is the connection $\check{\nabla}$ which can locally be expressed as

$$\check{\nabla}_U = d + 2\pi\sqrt{-1}(\xi_1 dy_1 + \xi_2 dy_2).$$

Let \mathcal{L} be the line bundle determined by $\check{\nabla}$. Then the degree of its restriction to E_i is given by

$$\begin{aligned} \deg \mathcal{L}|_{E_i} &= \int_{E_i} \frac{\sqrt{-1}}{2\pi} F_{\check{\nabla}} \\ &= - \int_{E_i} (d\xi_1 \wedge dy_1) \\ &= -(\xi_1(s_i) - \xi_1(s_{i-1})). \end{aligned}$$

We have the second equality because y_2 is constant (and $x_2 = -\lambda = 0$) on E_i . Hence the isomorphism class of the line bundle \mathcal{L} is completely determined by the increment of the angle coordinate ξ_1 on the Lagrangian section L as one moves from $(s_{i-1}, 0)$ to $(s_i, 0)$.

Now we prove Theorem 1.1:

Proof of Theorem 1.1. Recall that the Hamiltonian isotopy class of the Lagrangian submanifold L_γ remains unchanged when we deform γ in a fixed homotopy class relative to the boundary conditions $\lim_{t \rightarrow -\infty} |\gamma(t)| = 0$ and $\lim_{t \rightarrow \infty} |\gamma(t)| = \infty$. So, up to a reparametrization of γ , we can deform the restriction of γ to (s_{i-1}, s_i) to a path arbitrary close to the concatenation of $\gamma_0|_{(s_{i-1}, s_i)}$ (the negative axis) with a loop winding around the circle $l_s := \{z \in \mathbb{C}^\times \mid |z| = e^{s_i}\}$ for $w_i(\gamma)$ times. Along γ_0 , the angle coordinate ξ_1 is constantly zero, and ξ increases by one when we wind around l_s once in the anti-clockwise direction. Hence, the increment $\xi_1(s_i) - \xi_1(s_{i-1})$ is precisely given by the i -th winding number $w_i(\gamma)$. \square

One way to visualize the Lagrangian submanifold L_γ is to observe that the curve $\tau_{s_0}^{s_i}(C_{s_0})$ is given by twisting C_{s_0} in the vanishing cycle for $\sum_{k=1}^i w_k(\gamma)$ times. Correspondingly, the increment of the angle coordinate ξ_1 as one goes from $(s_{i-1}, 0)$ to $(s_i, 0)$ is given by the i -th winding number $w_i(\gamma)$ of γ .

5 Homological mirror symmetry

Let \mathcal{X} be a smooth toric Fano stack of dimension d and \mathcal{K} be the total space of its canonical bundle. The mirror of \mathcal{X} is given by a Laurent polynomial

$$W : (\mathbb{C}^\times)^d \rightarrow \mathbb{C}$$

whose Newton polytope coincides with the fan polytope of \mathcal{X} . By choosing sufficiently general W , one may assume that

- W is *tame* in the sense that the gradient $\|\nabla W\|$ is bounded from below by a positive number outside of a compact set,
- all the critical points of W are *non-degenerate* in the sense that the Hessian at each critical point is a non-degenerate quadratic form,
- all the critical values of W are distinct, and
- the origin is not a critical value of W .

When $\mathcal{X} = \mathbb{P}(1, n)$ is the weighted projective line of weight $(1, n)$, one can take

$$W : \mathbb{C}^\times \rightarrow \mathbb{C}, \quad z \mapsto z + 1/z^n$$

as its mirror. This is related to the function $1/z + z^n$ appearing in (1.6) by an automorphism $z \mapsto 1/z$ of the torus, and our choice here is made only for aesthetic reason (Figure 5.5 below looks nicer for this choice). The critical points of W are given by $z = \sqrt[n+1]{n} \zeta_{n+1}^i$, $i = 0, \dots, n$, with critical values $\sqrt[n+1]{n}(1 + 1/n) \zeta_{n+1}^i$. Here $\zeta_{n+1} = \exp(2\pi\sqrt{-1}/(n+1))$ is a primitive $(n+1)$ -st root of unity.

We equip $(\mathbb{C}^\times)^d$ with the Kähler form

$$\omega = -\frac{\sqrt{-1}}{2} \left(\frac{dz_1 \wedge d\bar{z}_1}{|z_1|^2} + \dots + \frac{dz_d \wedge d\bar{z}_d}{|z_d|^2} \right),$$

and define a horizontal distribution on $(\mathbb{C}^\times)^d$ as the orthogonal complement to the tangent spaces to fibers of W . Choose a sufficiently large closed disk $B \subset \mathbb{C}$ and a point $*$ on the boundary of B , so that all the critical values of W is contained in the interior of B . The restriction $W|_S : S \rightarrow B$ of W to the intersection S of $W^{-1}(B)$ and a sufficiently large closed ball in $(\mathbb{C}^\times)^d$ is a *compact convex Lefschetz fibration* [McL09, Definition 2.14], i.e., a family of compact convex symplectic manifolds with at worst non-degenerate critical points. Here, a *compact convex symplectic manifold* (also known as a *Liouville domain*) is an exact symplectic manifold with boundary whose Liouville vector field points strictly outward along the boundary. We will write $W|_S$ as W by abuse of notation. By rounding the corners of S , one obtains a Liouville domain M . Its *completion* $\hat{M} = M \cup_{\partial M} (\partial M \times [1, \infty))$, obtained by gluing the positive half of the symplectization to the boundary, is symplectomorphic to $(\mathbb{C}^\times)^d$.

When $W = z + 1/z^n$, we fix a large positive real number $*$ as a base point, and let B to be a closed disk of radius $*$ centered at the origin. Its inverse image $S := W^{-1}(B)$ is symplectomorphic to a cylinder $[0, L] \times S^1$ for some L , equipped with the standard symplectic form $\omega = dr \wedge d\theta$. The fiber $S_* := W^{-1}(*)$ consists of $n + 1$ points, one of which is approximately $*$ and n of which are approximately n -th roots of $1/*$.

With a compact convex Lefschetz fibration, Abouzaid [Abo06, Abo09] associates a category $\mathcal{F}(S, S_*)$ consisting of exact Lagrangian submanifolds L with boundaries, which are *admissible* in the sense that

- the boundary ∂L is a Lagrangian submanifold in the interior of S_* ,
- L projects by W to a curve $\gamma \subset B$ in a neighborhood of ∂L , and
- L coincides with the parallel transport of ∂L along γ in this neighborhood.

See Figure 5.1 for a schematic picture of admissible Lagrangians.

For a pair (L_1, L_2) of admissible Lagrangian submanifolds, the space $\text{hom}_{\mathcal{F}(S, S_*)}(L_1, L_2)$ of morphisms is defined as the Lagrangian intersection Floer complex $CF(L_1^{\epsilon_1}, L_2)$ between $L_1^{\epsilon_1}$ and L_2 . Here $L_1^{\epsilon_1}$ is the Lagrangian submanifold obtained by perturbing the part of L_1 fibered over γ_1 to another Lagrangian submanifold fibered over the curve $\gamma_1^{\epsilon_1}$ starting from $*$ such that $\arg \gamma_1^{\epsilon_1'}(0) < \arg \gamma_2'(0) < \arg \gamma_1^{\epsilon_1'}(0) + \pi$ as in Figure 5.2, and one only looks at intersection points in the interior of S . For a sequence (L_1, \dots, L_k) of admissible Lagrangians, the A_∞ -operation is defined by perturbing L_i to $L_i^{\epsilon_i}$ such that $\arg \gamma_1^{\epsilon_1'}(0) < \arg \gamma_2^{\epsilon_2'}(0) < \dots < \arg \gamma_k^{\epsilon_k'}(0) < \arg \gamma_1^{\epsilon_1'}(0) + \pi$ and counting virtual numbers of holomorphic disks bounded by these Lagrangian submanifolds. This gives an A_∞ -precategory, which can be promoted to an A_∞ -category by [Efi11, Theorem 1.2].

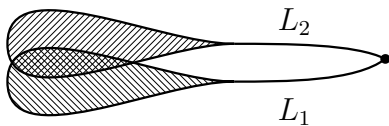

Figure 5.1: Admissible Lagrangians

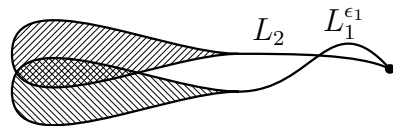

Figure 5.2: Perturbing L_1

A *vanishing path* is an embedded path $\gamma : [0, 1] \rightarrow B$ from the base point $*$ to a critical value of π avoiding other critical values. We assume that γ does not pass through the origin. By arranging the vanishing cycles along a vanishing path, one obtains an admissible

Lagrangian submanifold of S called the *Lefschetz thimble*. A *distinguished basis of vanishing paths* is a sequence $\gamma = (\gamma_1, \dots, \gamma_m)$ of mutually non-intersecting vanishing paths, one for each critical value and ordered according to $-\arg \gamma'_i(0)$. The corresponding sequence of Lefschetz thimbles will be written as $\Delta = (\Delta_1, \dots, \Delta_m)$, and the full subcategory of $\mathcal{F}(S, S_*)$ consisting of Δ will be denoted by $\mathcal{F}(\Delta)$. It is expected that

- Δ is a full exceptional collection in $D^b\mathcal{F}(S, S_*)$, so that $D^b\mathcal{F}(\Delta)$ is equivalent to $D^b\mathcal{F}(S, S_*)$ and hence is independent of the choice of Δ , and
- $D^b\mathcal{F}(S, S_*)$ is equivalent to the derived category $D^b\mathcal{F}(W)$ of the *Fukaya-Seidel category* of W , defined in [Sei08b, Definition 18.12] as the $\mathbb{Z}/2\mathbb{Z}$ -invariant part of the Fukaya category of a branched double cover of a slight enlargement of S .

Homological mirror symmetry for toric Fano stacks can be formulated as follows:

Conjecture 5.1 (Kontsevich [Kon98]). *There exists an equivalence*

$$\Psi : D^b\mathcal{F}(\Delta) \rightarrow D^b \text{coh } \mathcal{X} \quad (5.1)$$

of triangulated categories.

Let $\sigma : S \rightarrow S$ be a Hamiltonian diffeomorphism which covers the Dehn twist $\bar{\sigma} : B \rightarrow B$ along a circle near the boundary of B . The resulting push-forward functor $\sigma_* : \mathcal{F}(S, S_*) \rightarrow \mathcal{F}(S, S_*)$ is an autoequivalence of the Fukaya category, which wraps a Lagrangian as shown in Figure 5.3.

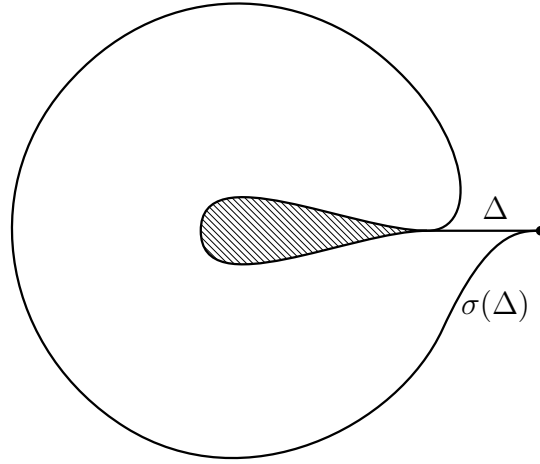

Figure 5.3: The functor σ_*

One can equip the direct sum

$$\mathcal{A} = \bigoplus_{i,j=0}^m \bigoplus_{k=0}^{\infty} \text{Hom}_{\mathcal{F}(S, S_*)}(\sigma^k(\Delta_i), \Delta_j)$$

with a ring structure given by

$$\begin{array}{ccc} \text{Hom}(\sigma^{k_2}(\Delta_{i_2}), \Delta_{i_3}) & \otimes & \text{Hom}(\sigma^{k_1}(\Delta_{i_1}), \Delta_{i_2}) & \rightarrow & \text{Hom}(\sigma^{k_1+k_2}(\Delta_{i_1}), \Delta_{i_3}) \\ \Downarrow & & \Downarrow & & \Downarrow \\ x_2 & & x_1 & \mapsto & \mathfrak{m}_2(x_2, \sigma_*^{k_2}(x_1)). \end{array}$$

The continuation map

$$\mathfrak{t} : \mathrm{Hom}_{\mathcal{F}(S, S_*)}(\sigma^k(\Delta_i), \Delta_j) \rightarrow \mathrm{Hom}_{\mathcal{F}(S, S_*)}(\sigma^{k+1}(\Delta_i), \Delta_j)$$

in Floer theory, obtained by counting solutions to inhomogeneous Cauchy-Riemann equation (cf. e.g [AS10, (3.35)]), induces an endomorphism \mathfrak{T} of this ring.

On the mirror side, there is a distinguished autoequivalence

$$S(-) = - \otimes \omega_{\mathcal{X}}[d] : D^b \mathrm{coh} \mathcal{X} \rightarrow D^b \mathrm{coh} \mathcal{X}$$

called the *Serre functor* [BK89]. Let $s \in H^0(\omega_{\mathcal{X}}^\vee)$ be a section characterized by the property that the zero locus $s^{-1}(0)$ is the union of all the toric divisors of \mathcal{X} . This section induces a natural transformation

$$\mathfrak{s} : S[-d] \rightarrow \mathrm{id} \tag{5.2}$$

which acts on objects by multiplication by $s : S[-d](X) = X \otimes \omega_{\mathcal{X}} \rightarrow \mathrm{id}(X) = X$. One can equip the direct sum

$$\mathcal{B} = \bigoplus_{i,j=0}^m \bigoplus_{k=0}^{\infty} \mathrm{Hom}_{\mathcal{X}}(E_i \otimes \omega_{\mathcal{X}}^k, E_j)$$

with a ring structure given by

$$\begin{aligned} & \mathrm{Hom}(E_{i_2} \otimes \omega_{\mathcal{X}}^{k_2}, E_{i_3}) \otimes \mathrm{Hom}(E_{i_1} \otimes \omega_{\mathcal{X}}^{k_1}, E_{i_2}) \\ & \quad \xrightarrow{\sim} \mathrm{Hom}(E_{i_2} \otimes \omega_{\mathcal{X}}^{k_2}, E_{i_3}) \otimes \mathrm{Hom}(E_{i_1} \otimes \omega_{\mathcal{X}}^{k_1+k_2}, E_{i_2} \otimes \omega_{\mathcal{X}}^{k_2}) \\ & \quad \rightarrow \mathrm{Hom}(E_{i_1} \otimes \omega_{\mathcal{X}}^{k_1+k_2}, E_{i_3}). \end{aligned}$$

The natural transformation (5.2) induces a ring endomorphism \mathfrak{S} of \mathcal{B} .

Assume that the collection $(E_i)_{i=1}^m$ is *cyclic* in the sense that

$$\mathrm{Ext}^i(E_k \otimes \omega_{\mathcal{X}}^j, E_\ell) = 0 \text{ for any } i \neq 0, \text{ any } j \geq 0 \text{ and any } k, \ell \in \{1, \dots, m\}.$$

This implies that the ring \mathcal{B} is concentrated in degree zero, so that there are no higher A_∞ -operations for degree reason. Although cyclicity is a strong condition, it is known that any toric Fano stack in dimension two has a cyclic full exceptional collection of line bundles [IU]. It is not known whether any toric Fano stack has a cyclic full exceptional collection of complexes.

Conjecture 5.2 (Kontsevich, Seidel [Sei09, Example 5]). *There is a ring isomorphism $\mathcal{A} \xrightarrow{\sim} \mathcal{B}$ sending the ring endomorphism \mathfrak{T} to \mathfrak{S} .*

It is further expected that \mathfrak{t} is the first component of a canonical natural transform

$$\mathfrak{t} : \sigma_* \rightarrow \mathrm{id} \tag{5.3}$$

which is mirror to the natural transformation (5.2).

When $W = z + 1/z^n$, we take a distinguished basis $(\gamma_i)_{i=0}^n$ of vanishing paths as in Figure 5.4. The corresponding Lefschetz thimbles $(\Delta_i)_{i=0}^n$ are Lagrangian submanifolds

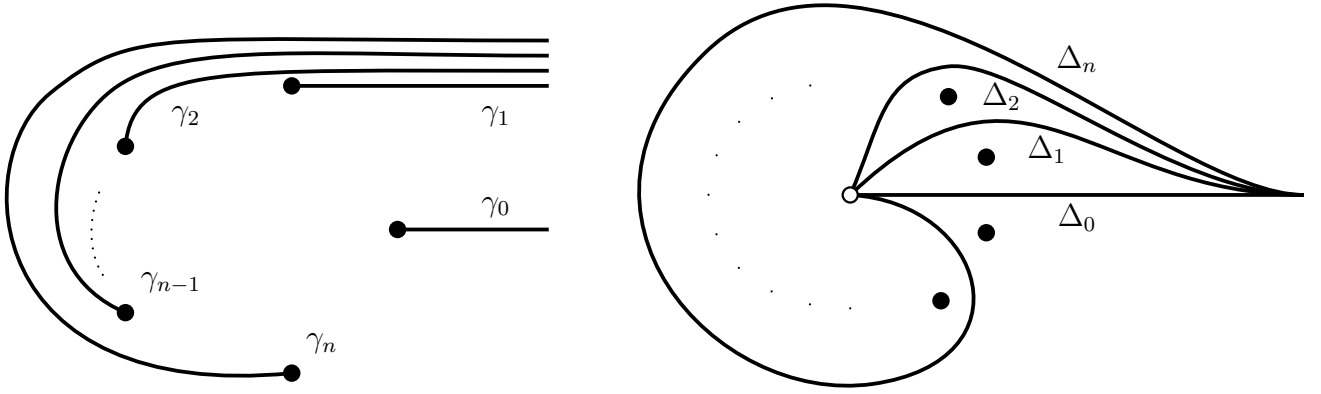

Figure 5.4: Vanishing paths on the W -plane Figure 5.5: Lefschetz thimbles on the z -plane

of S with boundaries on S_* as shown in Figure 5.5. The Hamiltonian diffeomorphism $\sigma : S \rightarrow S$ behaves as $z \mapsto \exp(2\pi\sqrt{-1})z$ for $|z| \gg 1$, and $z \mapsto \exp(-2\pi\sqrt{-1}/n)z$ for $|z| \ll 1$. We write the images of the Lefschetz thimbles as $\Delta_{-(n+1)k+i} = \sigma^k(\Delta_i)$.

On the mirror side, we write the homogeneous coordinate ring of $\mathcal{X} = \mathbb{P}(1, n)$ as $\mathbb{C}[x, y]$ where $\deg x = 1$ and $\deg y = n$. The canonical bundle is given by $\omega_{\mathcal{X}} = \mathcal{O}_{\mathcal{X}}(-n-1)$, and the full exceptional collection

$$(E_0, E_1, \dots, E_n) = (\mathcal{O}_{\mathcal{X}}, \mathcal{O}_{\mathcal{X}}(1), \dots, \mathcal{O}_{\mathcal{X}}(n))$$

of line bundles is cyclic.

Theorem 5.3. *Conjecture 5.2 holds for $\mathcal{X} = \mathbb{P}(1, n)$ and $W = z + 1/z^n$.*

Proof. The Lefschetz thimble $\Delta_{-k(n+1)+i}$ starts from the critical point ${}^{n+1}\sqrt{n}\zeta_{n+1}^i$ and extends in two directions: One wraps around the origin k/n times and goes to the point in S_* approximated by $\zeta_n^{i-k} \cdot *^{-1/n}$. The other wraps around infinity k times and asymptotes to the point in S_* approximated by $*$. Figure 5.6 shows the picture of two Lefschetz thimbles. Here the top and the bottom edges of the rectangle are identified to form the cylinder $[0, L] \times S^1$, which is symplectomorphic to S . The vertical dotted line shows the locus where the absolute value is ${}^{n+1}\sqrt{n}$. The Lefschetz thimble Δ_0 is just the real line, and the Lefschetz thimble $\Delta_{-k(n+1)+i}$ is obtained from the Lefschetz thimble Δ_i by wrapping k times.

Write $k(n+1) - i = k'n + i'$ for $k' \in \mathbb{Z}$ and $i' \in \{0, \dots, n-1\}$. Then the thimbles $\Delta_{-k(n+1)+i}$ and Δ_0 intersect at $k'+1$ points, and we label these intersection points by the basis of $\text{Hom}(\mathcal{O}_{\mathbb{P}(1,n)}(-k(n+1)+i), \mathcal{O}_{\mathbb{P}(1,n)})$ as shown in Figure 5.6. Intersections between other Lefschetz thimbles can be labeled similarly. By choosing the standard grading on S determined by the holomorphic volume form dz/z and suitable gradings on Δ_i 's, one can arrange that $\text{Hom}_{\mathcal{F}(S, S_*)}(\Delta_i, \Delta_j)$ for $i \leq j$ have degree zero (and those for $i > j$ have degree one). It follows that the ring $\mathcal{A} = \bigoplus_{i,j=0}^m \bigoplus_{k=0}^{\infty} \text{Hom}_{\mathcal{F}(S, S_*)}(\sigma^k(\Delta_i), \Delta_j)$ is concentrated in degree zero, so that there are no higher A_{∞} -operations on \mathcal{A} . The multiplication on \mathcal{A} comes from a triangle on S , which is either of the ones shown in Figures 5.7 and 5.8. This

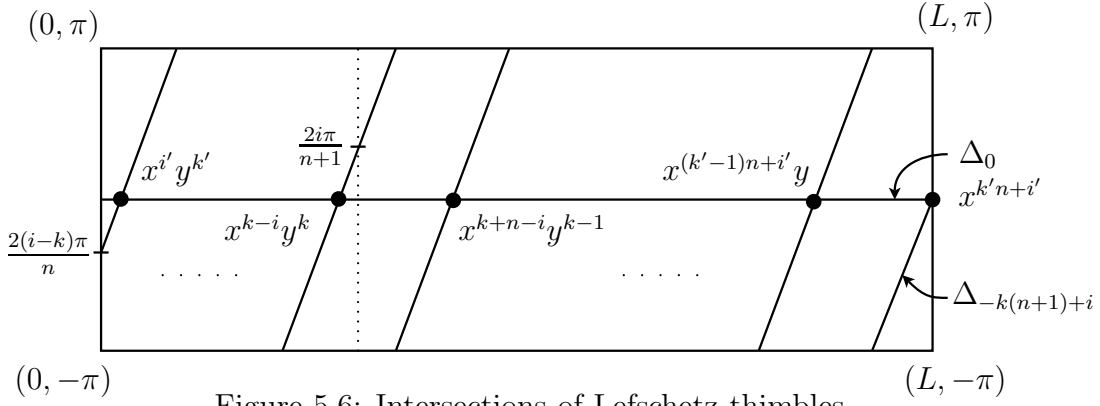

Figure 5.6: Intersections of Lefschetz thimbles

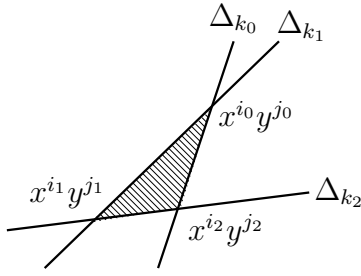

Figure 5.7: A triangle

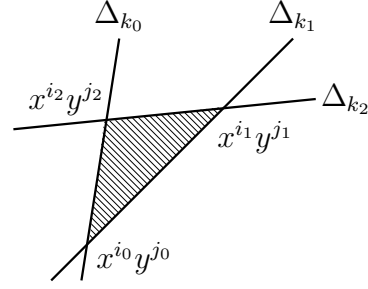

Figure 5.8: Another triangle

clearly matches the multiplication on \mathcal{B} (which is just the multiplication of polynomials), and Theorem 5.3 is proved. \square

For $q \in \text{Hom}_{\mathcal{F}(S, S_*)}(\sigma^w(\Delta_{i_0}), \Delta_{i_1})$, we define $\text{ord}(q)$ as the maximal integer d such that x is in the image of

$$\mathfrak{t}^d : \text{Hom}_{\mathcal{F}(S, S_*)}(\sigma^{w-d}(\Delta_{i_0}), \Delta_{i_1}) \rightarrow \text{Hom}_{\mathcal{F}(S, S_*)}(\sigma^w(\Delta_{i_0}), \Delta_{i_1}).$$

Proposition 5.4 below is an analogue of [Pas, Proposition 4.3], which will be useful later.

Proposition 5.4. *If a holomorphic triangle $\varphi : D^2 \rightarrow S$ contributes to the composition $x^{i_2}y^{j_2} = \mathfrak{m}_2(x^{i_1}y^{j_1}, x^{i_0}y^{j_0})$ for $x^{i_0}y^{j_0} \in \text{Hom}_{\mathcal{F}(S, S_*)}(\Delta_{k_0}, \Delta_{k_1})$, $x^{i_1}y^{j_1} \in \text{Hom}_{\mathcal{F}(S, S_*)}(\Delta_{k_1}, \Delta_{k_2})$, and $x^{i_2}y^{j_2} \in \text{Hom}_{\mathcal{F}(S, S_*)}(\Delta_{k_0}, \Delta_{k_2})$, then the intersection number between this triangle and the divisor S_0 is given by*

$$\varphi(D^2) \cdot S_0 = \text{ord}(x^{i_2}y^{j_2}) - \text{ord}(x^{i_0}y^{j_0}) - \text{ord}(x^{i_1}y^{j_1}). \quad (5.4)$$

Proof. Since $n+1\sqrt{n}$ is close to 1, one can perturb Figure 5.6 slightly to set the dotted vertical line to be the unit circle on \mathbb{C}^\times without changing the intersections of triangles with S_0 . Then S_0 is equidistributed on the dotted vertical line with vertical coordinates $(2j+1)\pi/(2n+2)$ for $j = 0, \dots, n$.

We write $d_\ell = \text{ord}(x^{i_\ell}y^{j_\ell})$ and $x^{i_\ell}y^{j_\ell} = (xy)^{d_\ell}x^{i_\ell-d_\ell}y^{j_\ell-d_\ell}$ for $\ell = 0, 1, 2$. If $i_\ell - d_\ell = 0$ for $\ell = 0, 1$ or $j_\ell - d_\ell = 0$ for $\ell = 0, 1$, then the whole triangle is either on the left or on the right of the dotted vertical line in Figure 5.6, and both sides of (5.4) is zero. If $a := i_0 - d_0 > 0$ and $b := j_1 - d_1 > 0$, then the triangle D looks as in Figure 5.7, and the vertical dotted line cuts D into two. The number of points in S_0 on the part of the

vertical dotted line bounded by Δ_{i_0} and Δ_{i_1} is given by a , and that by Δ_{i_1} and Δ_{i_2} is given by b (here we are working on the universal cover of the cylinder S). The vertical dotted line is on the right or the left of the vertex $x^{i_2}y^{j_2}$ depending on whether $a > b$ or $a < b$ (and exactly on the line if $a = b$). It follows that both sides of (5.4) is given by $\max\{a, b\}$ in this case. The case $j_0 - d_0 > 0$ and $i_1 - d_1 > 0$ is similar, and Proposition 5.4 is proved. \square

An admissible Lagrangian submanifold Δ of S can be completed to a Lagrangian submanifold $\hat{\Delta} := \Delta \cup_{\partial\Delta} (\partial\Delta \times [1, \infty))$ of the completion \hat{M} . Given a pair (Δ_1, Δ_2) of admissible Lagrangians, the *wrapped Floer cohomology* [AS10] is defined by

$$HW(\hat{\Delta}_1, \hat{\Delta}_2) := \varinjlim_w HF(\phi_w(\hat{\Delta}_1), \hat{\Delta}_2),$$

where ϕ_w is the time w flow by a Hamiltonian H which behaves as $H(x, r) = r$ on the cylindrical end $(x, r) \in \partial M \times [1, \infty)$ of \hat{M} .

Let

$$Y' := \{(z, u, v) \in (\mathbb{C}^\times)^d \times \mathbb{C}^2 \mid W(z) = uv\}$$

be the fiber of the double suspension of W .

Theorem 5.5 (Seidel [Sei10, Theorem 1]). *Assume that the derived Fukaya-Seidel category $D^b\mathcal{F}(W)$ is quasi-equivalent to the derived category of coherent sheaves on \mathcal{X} as an A_∞ -category. Then there exists a full embedding*

$$D^b \text{coh}_0 \mathcal{K} \hookrightarrow D^b\mathcal{F}(Y')$$

of triangulated categories, where $D^b \text{coh}_0 \mathcal{K}$ is the full subcategory of $D^b \text{coh} \mathcal{K}$ consisting of complexes whose cohomologies are supported on the zero-section, and $\mathcal{F}(Y')$ is the Fukaya category of Y' .

The manifold Y' is an affine algebraic variety, and hence a Stein manifold of finite type, so that it is symplectomorphic to the completion \hat{N} of the Liouville domain N obtained by intersecting it with a sufficiently large ball. Consider the projection

$$\begin{array}{ccc} \varpi : & N & \rightarrow (\mathbb{C}^\times)^d \\ & \cup & \cup \\ & (z, u, v) & \mapsto z \end{array}$$

and set $E = N \cap \varpi^{-1}(S)$. The restriction $\varpi|_E : E \rightarrow S$ of the projection, which we will write ϖ by abuse of notation, is a compact convex Lefschetz fibration, whose discriminant locus is $S_0 := W^{-1}(0)$. The completion \hat{E} of E , obtained by first completing in the direction of the fiber of ϖ and then extending it to the completion of the base S , is symplectomorphic to Y' .

We define the Lagrangian submanifolds $L_i \subset E$ which are \mathbb{R} -fibrations over the Lefschetz thimbles $\Delta_i \subset S$ as in Section 3. When $W = z + 1/z^n$, the Lagrangian submanifold L_0 is given by

$$L_0 := \{(z, u, v) \in E \mid z, u, v \in \mathbb{R}^{>0}\}, \quad (5.5)$$

and other Lagrangian submanifolds L_i are given by $L_i = \zeta_{n+1}^i \cdot L_0$, where ζ_{n+1}^i acts on E by sending (z, u, v) to $(\zeta_{n+1}^i z, \zeta_{n+1}^i u, v)$.

Recall from [McL09, Definition 2.21] that a *Lefschetz admissible Hamiltonian* is a smooth function $H(\mathbf{z}, u, v)$ on Y' which can be written, outside of a compact set, as the sum $H_b(\mathbf{z}) + H_f(u, v)$ of admissible Hamiltonians $H_b(\mathbf{z})$ and $H_f(u, v)$ on the base and the fiber respectively. The map ϖ is not an honest Lefschetz fibration but a Bott-Morse analogue of a Lefschetz fibration in general. It is an honest Lefschetz fibration when $W = z + 1/z^n$ for dimensional reason.

The *Lefschetz wrapped Floer cohomology* is defined as the direct limit

$$HW_l(\hat{L}_i, \hat{L}_j) := \varinjlim_w HF(\phi_w(\hat{L}_i), \hat{L}_j)$$

where $\phi_w : Y' \rightarrow Y'$ is the time w flow defined by the Hamiltonian H . Set

$$\mathcal{A}_w := \bigoplus_{i,j=1}^m HF(\phi_w(\hat{L}_i), \hat{L}_j)$$

and

$$\mathcal{A} := \varinjlim_{w \rightarrow \infty} \mathcal{A}_w = \bigoplus_{i,j=1}^m HW_l(\hat{L}_i, \hat{L}_j).$$

The map

$$\phi_{w+1,w}^{\mathcal{A}} : HF(\phi_w(\hat{L}_i), \hat{L}_j) \rightarrow HF(\phi_{w+1}(\hat{L}_i), \hat{L}_j)$$

in the definition of the inductive limit is the continuation map for the Hamiltonian diffeomorphism $\phi_1 : Y' \rightarrow Y'$. The universal map to the inductive limit is denoted by

$$\phi_{\infty,w}^{\mathcal{A}} : HF(\phi_w(\hat{L}_i), \hat{L}_j) \rightarrow \mathcal{A}.$$

The \mathbb{C} -vector space \mathcal{A} has a ring structure coming from

$$\begin{array}{ccc} HF(\phi_{w_2}(\hat{L}_j), \hat{L}_k) \otimes HF(\phi_{w_1}(\hat{L}_i), \hat{L}_j) & \rightarrow & HF(\phi_{w_1+w_2}(\hat{L}_i), \hat{L}_j) \\ \Downarrow & & \Downarrow \\ q \otimes r & \mapsto & \mathbf{m}_2(q, (\phi_{w_2})_*(r)). \end{array}$$

One can show the ring isomorphism [CPU, Theorem A.2]

$$\mathcal{A} \cong \bigoplus_{i_0, i_1=1}^n HW(\hat{L}_{i_0}, \hat{L}_{i_1})$$

with the ordinary wrapped Floer cohomology along the lines of [McL09, Theorem 2.22].

Note that the monodromy of the conic fibration $\varpi : E \rightarrow S$ around the discriminant S_0 is given by the Dehn twist along the vanishing cycle, which is inverse to the wrapping on the fiber. It follows that for a positive integer w , the intersection points $\phi_w(\hat{L}_{i_0}) \cap \hat{L}_{i_1}$ can be parametrized as q_j for some $q \in \sigma^w(\Delta_{i_0}) \cap \Delta_{i_1}$ and an integer $j \in [0, \text{ord}(q) + w]$ indicating the position in the fiber of ϖ counted from the top as shown in Figures 5.9

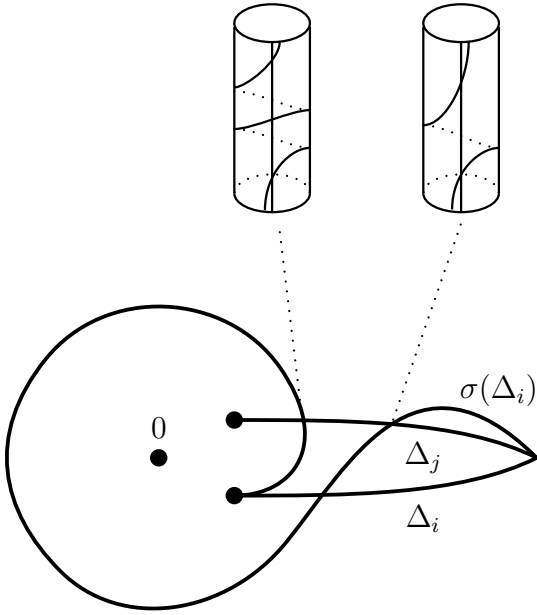

Figure 5.9: Wrapping once

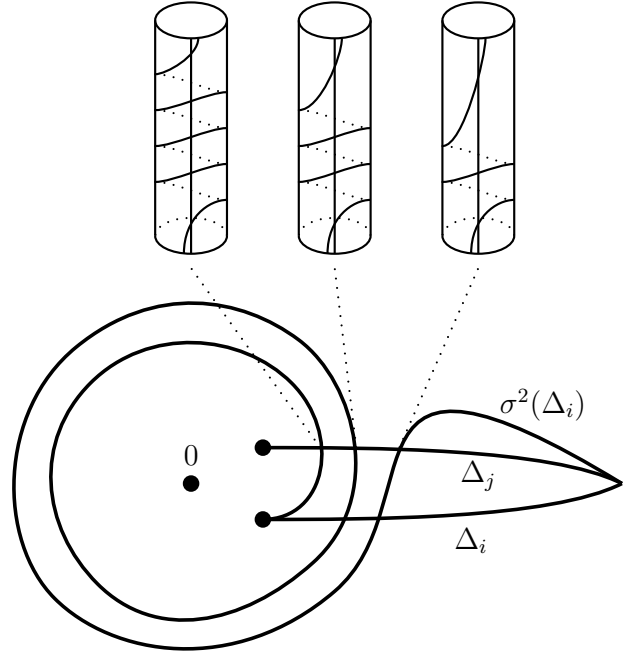

Figure 5.10: Wrapping twice

and 5.10. The continuation map $\phi_{w+1,w}^{\mathcal{A}} : \mathcal{A}_w \rightarrow \mathcal{A}_{w+1}$ is written as $\phi_{w+1,w}^{\mathcal{A}}(q_j) = \mathfrak{t}(q)_{j+1}$ in this parametrization. We write $q = \mathfrak{t}^{\text{ord}(q)}(q')$, and consider the \mathbb{C} -linear map

$$\begin{array}{ccc} \psi_w : HF(\phi_w(\hat{L}_{i_0}), \hat{L}_{i_1}) & \rightarrow & \bigoplus_{k=0}^{2w} \text{Hom}_{\mathcal{X}}(E_{i_0} \otimes \omega_{\mathcal{X}}^k, E_{i_1}) \\ \cup & & \cup \\ q_j & \mapsto & (s-1)^j Q' \end{array} \quad (5.6)$$

where $Q' \in \text{Hom}_{\mathcal{X}}(E_{i_0} \otimes \omega_{\mathcal{X}}^{w-\text{ord}(q)}, E_{i_1})$ corresponds to $q' \in \text{Hom}_{\mathcal{F}(S,S_*)}(\sigma^{w-\text{ord}(q)}(\Delta_{i_0}), \Delta_{i_1})$ under the ring isomorphism in Theorem 5.3.

Let

$$\mathcal{B} := \varinjlim_{w \rightarrow \infty} \mathcal{B}_w, \quad \mathcal{B}_w := \bigoplus_{k=0}^{2w} \bigoplus_{i,j=0}^n \text{Hom}_{\mathcal{X}}(E_i \otimes \omega_{\mathcal{X}}^k, E_j)$$

be the direct limit of the right hand side of (5.6) with respect to the map

$$\phi_{w+1,w}^{\mathcal{B}} : \mathcal{B}_w \rightarrow \mathcal{B}_{w+1}$$

given by the multiplication by $1-s$

$$\bigoplus_{k=0}^{2w} \bigoplus_{i,j=0}^n \text{Hom}_{\mathcal{X}}(E_i \otimes \omega_{\mathcal{X}}^k, E_j) \xrightarrow{1-s} \bigoplus_{k=0}^{2w+1} \bigoplus_{i,j=0}^n \text{Hom}_{\mathcal{X}}(E_i \otimes \omega_{\mathcal{X}}^k, E_j)$$

followed by the inclusion

$$\bigoplus_{k=0}^{2w+1} \bigoplus_{i,j=0}^n \text{Hom}_{\mathcal{X}}(E_i \otimes \omega_{\mathcal{X}}^k, E_j) \hookrightarrow \bigoplus_{k=0}^{2w+2} \bigoplus_{i,j=0}^n \text{Hom}_{\mathcal{X}}(E_i \otimes \omega_{\mathcal{X}}^k, E_j).$$

The multiplication in \mathcal{B} is defined by

$$\begin{array}{ccc} \mathcal{B}_{w_2} \otimes \mathcal{B}_{w_1} & \rightarrow & \mathcal{B}_{w_1+w_2} \\ \cup & & \cup \\ Q \otimes R & \mapsto & Q \cdot R. \end{array}$$

Proposition 5.6. *One has an isomorphism*

$$\mathcal{B} \xrightarrow{\sim} \bigoplus_{i,j=0}^n \mathrm{Hom}_{\tilde{\mathcal{Y}}}(\pi^* E_i|_{\tilde{\mathcal{Y}}}, \pi^* E_j|_{\tilde{\mathcal{Y}}}) \quad (5.7)$$

of rings.

Proof. By combining

$$\begin{aligned} \bigoplus_{i,j=0}^n \mathrm{Hom}_{\mathcal{K}}(\pi^* E_i, \pi^* E_j) &\cong \bigoplus_{i,j=0}^n \mathrm{Hom}_{\mathcal{X}}(E_i, \pi_* \pi^* E_j) \\ &\cong \bigoplus_{i,j=0}^n \mathrm{Hom}_{\mathcal{X}}(E_i, E_j \otimes \pi_* \mathcal{O}_{\mathcal{K}}) \\ &\cong \bigoplus_{i,j=0}^n \mathrm{Hom}_{\mathcal{X}} \left(E_i, E_j \otimes \left(\bigoplus_{k=0}^{\infty} \omega_{\mathcal{X}}^{-k} \right) \right) \\ &\cong \varinjlim_{w \rightarrow \infty} \bigoplus_{k=0}^w \bigoplus_{i,j=0}^n \mathrm{Hom}_{\mathcal{X}}(E_i \otimes \omega_{\mathcal{X}}^k, E_j) \end{aligned}$$

with

$$\mathrm{Hom}(M|_{\tilde{\mathcal{Y}}}, N|_{\tilde{\mathcal{Y}}}) = \varinjlim \left(\mathrm{Hom}(M, N) \xrightarrow{1-s} \mathrm{Hom}(M, N) \xrightarrow{1-s} \dots \right)$$

for any objects M and N of $D^b \mathrm{coh} \mathcal{K}$ (cf. [Sei08a, (1.13)]), one obtains an isomorphism

$$\bigoplus_{i,j=0}^n \mathrm{Hom}_{\tilde{\mathcal{Y}}}(\pi^* E_i|_{\tilde{\mathcal{Y}}}, \pi^* E_j|_{\tilde{\mathcal{Y}}}) \cong \varinjlim_{w \rightarrow \infty} \bigoplus_{k=0}^{2w} \bigoplus_{i,j=0}^n \mathrm{Hom}_{\mathcal{X}}(E_i \otimes \omega_{\mathcal{X}}^k, E_j)$$

of \mathbb{C} -vector spaces. The multiplication in \mathcal{B} commutes with this \mathbb{C} -linear isomorphism, and Proposition 5.6 is proved. \square

Proposition 5.7. *The maps ψ_w are compatible with the composition, i.e.,*

$$\psi_{w_1+w_2}(\mathbf{m}_2(q_j, r_k)) = \psi_{w_2}(q_j) \cdot \psi_{w_1}(r_k) \quad (5.8)$$

for any $q_j \in \phi_{w_2}(\hat{L}_{i_1}) \cap \hat{L}_{i_2}$ and $r_k \in \phi_{w_1}(\hat{L}_{i_0}) \cap \hat{L}_{i_1}$.

Proof. Since the Lagrangian submanifolds \hat{L}_i are fibered over Δ_i , any holomorphic triangle in $\tilde{\varphi} : D^2 \rightarrow E$ contributing to $\mathbf{m}_2(q_j, r_k)$ projects to a holomorphic triangle $\varphi = \varpi \circ \tilde{\varphi} : D^2 \rightarrow S$ contributing to $\mathbf{m}_2(q, r)$. Given a holomorphic triangle $\varphi : D^2 \rightarrow S$ contributing

to $p = \mathbf{m}_2(q, r)$, the contributions to $\mathbf{m}_2(q_j, r_k)$ of holomorphic triangles $\tilde{\varphi} : D^2 \rightarrow E$ projecting to φ is computed by Pascaleff [Pas, Proposition 4.4] as

$$\mathbf{m}_2(q_j, r_k) = \sum_{t=0}^{\ell} \binom{\ell}{t} p_{j+k+t},$$

where $\ell = \varphi(D^2) \cdot S_0$ is the intersection number of the triangle and the discriminant S_0 of the fibration $\varpi : E \rightarrow S$. It follows that

$$\begin{aligned} \psi_{w_1+w_2}(\mathbf{m}_2(q_j, r_k)) &= \sum_{t=0}^{\ell} \binom{\ell}{t} \psi_{w_1+w_2}(p_{j+k+t}) \\ &= \sum_{t=0}^{\ell} \binom{\ell}{t} (s-1)^{j+k+t} P'. \end{aligned}$$

On the right hand side of (5.8), one has

$$\begin{aligned} \psi_{w_2}(q_j) \cdot \psi_{w_1}(r_k) &= (s-1)^j Q' \cdot (s-1)^k R' \\ &= (s-1)^{j+k} Q' R' \\ &= (s-1)^{j+k} s^{\ell'} P' \\ &= \sum_{t=0}^{\ell'} \binom{\ell'}{t} (s-1)^{j+k+t} P' \end{aligned}$$

where $\ell' = \text{ord}(p) - \text{ord}(q) - \text{ord}(r)$. Now one has $\ell = \ell'$ by Proposition 5.4, and Proposition 5.7 is proved. \square

Proposition 5.8. *The maps ψ_w induce an isomorphism $\psi : \mathcal{A} \xrightarrow{\sim} \mathcal{B}$ of rings.*

Proof. The maps ψ_w induce a map $\psi : \mathcal{A} \rightarrow \mathcal{B}$ between inductive limits since

$$\begin{aligned} \psi_{w+1}(\phi_{w+1,w}^{\mathcal{A}}(q_i)) &= \psi_{w+1}(q_{i+1}) \\ &= (s-1)^{i+1} \cdot Q' \\ &= \phi_{w+1,w}^{\mathcal{B}}((s-1)^i \cdot Q') \\ &= \phi_{w+1,w}^{\mathcal{B}}(\psi_w(q_i)). \end{aligned}$$

For any element $q \in \text{Hom}_{\tilde{y}}(\pi^* E_i|_{\tilde{y}}, \pi^* E_j|_{\tilde{y}})$, one can take sufficiently large w_1 so that $(s-1)^{w_1} q$ extends to an element of $\text{Hom}_{\mathcal{K}}(\pi^* E_i, \pi^* E_j)$. Then one takes another sufficiently large w_2 so that $(s-1)^{w_1} q$ comes from $\bigoplus_{k=0}^{w_2} \text{Hom}_{\mathcal{X}}(E_i \otimes \omega_{\mathcal{X}}^k, E_j) \subset \text{Hom}_{\mathcal{K}}(\pi^* E_i, \pi^* E_j)$. Then q is in the image of $\psi \circ \phi_{\infty, w_1+w_2}^{\mathcal{A}} : \mathcal{A}_{w_1+w_2} \rightarrow \mathcal{B}$, which shows that ψ is surjective.

Note that the map $\phi_{\infty, w}^{\mathcal{B}} : \mathcal{B}_w \rightarrow \mathcal{B}$ is injective since each map $\phi_{w+1, w}^{\mathcal{B}} : \mathcal{B}_w \rightarrow \mathcal{B}_{w+1}$ is injective. The map ψ_w is also injective, and hence the map $\psi \circ \phi_{\infty, w}^{\mathcal{A}} = \phi_{\infty, w}^{\mathcal{B}} \circ \psi_w : \mathcal{A}_w \rightarrow \mathcal{B}$ is injective. This implies the injectivity of ψ , and Proposition 5.8 is proved. \square

Now we prove Theorem 1.2.

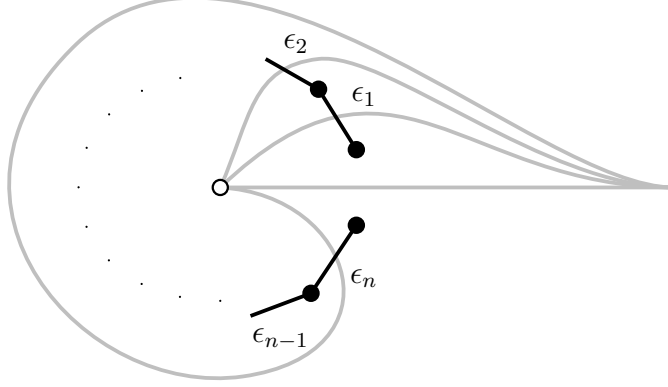

Figure 5.11: The dual cycles

Proof of Theorem 1.2. Recall that an object \mathcal{E} in a triangulated category is *acyclic* if $\text{End}^*(\mathcal{E})$ is concentrated in degree zero. It is a *generator* if $\text{Hom}(\mathcal{E}, X) = 0$ implies $X \cong 0$. An acyclic generator is called a *tilting object*. Since the exceptional collection $(E_i)_{i=0}^n$ is full, the pull-back $\bigoplus_{i=0}^n \pi^* E_i$ is a generator of $D^b \text{coh } \mathcal{K}$. Cyclicity of $(E_i)_{i=0}^n$ implies the acyclicity of $\bigoplus_{i=0}^n \pi^* E_i$. This shows that $\bigoplus_{i=0}^n \pi^* E_i$ is a tilting object. It follows that the restriction $\bigoplus_{i=0}^n \pi^* E_i|_{\check{\mathcal{Y}}}$ is a tilting object. (In general, the restriction of a generator to an open subset is a generator, and the restriction of an acyclic object to the complement of a principal divisor is acyclic.) Morita theory for derived categories [Ric89, Bon89] shows that $D^b \text{coh } \check{\mathcal{Y}}$ is equivalent to the derived category of finitely-generated modules over $\text{End}(\bigoplus_{i=0}^n \pi^* E_i|_{\check{\mathcal{Y}}})$.

The direct sum $\bigoplus_i \hat{L}_i$ is acyclic by Proposition 5.8, and it is a generator of \mathcal{W}' by definition. It follows that $D^b \mathcal{W}'$ is equivalent to the derived category of finitely-generated modules over $\text{End}(\bigoplus_{i=0}^n \hat{L}_i)$, which is isomorphic to $\text{End}(\bigoplus_{i=0}^n \pi^* E_i|_{\check{\mathcal{Y}}})$ by Proposition 5.8. This concludes the proof of Theorem 1.2. \square

Finally we discuss the compatibility of Theorem 1.1 and Theorem 1.2. Let $(\epsilon_1, \dots, \epsilon_n)$ be the collection of line segments on E connecting points in $W^{-1}(0)$ as in Figure 5.11, so that the intersection numbers with Lefschetz thimbles are given by

$$\Delta_i \cdot \epsilon_j = \delta_{ij}, \quad i = 0, \dots, n, \quad j = 1, \dots, n.$$

One can choose a symplectomorphism $Y \xrightarrow{\sim} Y'$ in such a way that these intersection numbers correspond precisely to the winding numbers in Definition 3.2. The SYZ transforms of the resulting Lagrangians in Y are then given by line bundles $(\mathcal{L}_i)_{i=0}^n$ on \check{Y} satisfying

$$\deg \mathcal{L}_i|_{E_j} = \delta_{ij}$$

for $i = 0, \dots, n$ and $j = 1, \dots, n$. One can easily see, either from [KV00, Section 2] or by a direct calculation, that the endomorphism rings of $\bigoplus_{i=0}^n \pi^* E_i|_{\check{\mathcal{Y}}}$ and $\bigoplus_{i=0}^n \mathcal{L}_i$ are isomorphic, so that there is an equivalence $D^b \text{coh } \check{\mathcal{Y}} \xrightarrow{\sim} D^b \text{coh } \check{Y}$ sending $\pi^* E_i|_{\check{\mathcal{Y}}}$ to \mathcal{L}_i . This gives the compatibility of Theorem 1.1 and Theorem 1.2 discussed in Introduction.

References

- [AAK] Mohammed Abouzaid, Denis Auroux, and Ludmil Katzarkov, *Lagrangian fibrations on blowups of toric varieties and mirror symmetry for hypersurfaces*, arXiv:1205.0053.
- [Abo06] Mohammed Abouzaid, *Homogeneous coordinate rings and mirror symmetry for toric varieties*, *Geom. Topol.* **10** (2006), 1097–1157 (electronic). MR MR2240909 (2007h:14052)
- [Abo09] ———, *Morse homology, tropical geometry, and homological mirror symmetry for toric varieties*, *Selecta Math. (N.S.)* **15** (2009), no. 2, 189–270. MR MR2529936
- [AP01] D. Arinkin and A. Polishchuk, *Fukaya category and Fourier transform*, Winter School on Mirror Symmetry, Vector Bundles and Lagrangian Submanifolds (Cambridge, MA, 1999), *AMS/IP Stud. Adv. Math.*, vol. 23, Amer. Math. Soc., Providence, RI, 2001, pp. 261–274. MR 1876073 (2002k:32040)
- [AS10] Mohammed Abouzaid and Paul Seidel, *An open string analogue of Viterbo functoriality*, *Geom. Topol.* **14** (2010), no. 2, 627–718. MR 2602848 (2011g:53190)
- [Aur07] Denis Auroux, *Mirror symmetry and T-duality in the complement of an anti-canonical divisor*, *J. Gökova Geom. Topol. GGT* **1** (2007), 51–91. MR 2386535 (2009f:53141)
- [Aur09] ———, *Special Lagrangian fibrations, wall-crossing, and mirror symmetry*, *Surveys in differential geometry. Vol. XIII. Geometry, analysis, and algebraic geometry: forty years of the Journal of Differential Geometry*, *Surv. Differ. Geom.*, vol. 13, Int. Press, Somerville, MA, 2009, pp. 1–47. MR MR2537081
- [BK89] A. I. Bondal and M. M. Kapranov, *Representable functors, Serre functors, and reconstructions*, *Izv. Akad. Nauk SSSR Ser. Mat.* **53** (1989), no. 6, 1183–1205, 1337. MR MR1039961 (91b:14013)
- [Bon89] A. I. Bondal, *Representations of associative algebras and coherent sheaves*, *Izv. Akad. Nauk SSSR Ser. Mat.* **53** (1989), no. 1, 25–44. MR MR992977 (90i:14017)
- [Cha13] Kwokwai Chan, *Homological mirror symmetry for A_n -resolutions as a T-duality*, *J. Lond. Math. Soc. (2)* **87** (2013), no. 1, 204–222. MR 3022713
- [CLL12] Kwokwai Chan, Siu-Cheong Lau, and Naichung Conan Leung, *SYZ mirror symmetry for toric Calabi-Yau manifolds*, *J. Differential Geom.* **90** (2012), no. 2, 177–250. MR 2899874
- [CPU] Kwokwai Chan, Daniel Pomerleano, and Kazushi Ueda, *Lagrangian torus fibrations and homological mirror symmetry for the conifold*, arXiv:1305.0968.
- [Dui80] J. J. Duistermaat, *On global action-angle coordinates*, *Comm. Pure Appl. Math.* **33** (1980), no. 6, 687–706. MR 596430 (82d:58029)

- [Efi11] A. I. Efimov, *A proof of the Kontsevich-Soibelman conjecture*, Mat. Sb. **202** (2011), no. 4, 65–84. MR 2830236 (2012m:53193)
- [Fan08] Bohan Fang, *Homological mirror symmetry is T-duality for \mathbb{P}^n* , Commun. Number Theory Phys. **2** (2008), no. 4, 719–742. MR MR2492197
- [FLTZ11] Bohan Fang, Chiu-Chu Melissa Liu, David Treumann, and Eric Zaslow, *The coherent-constructible correspondence and homological mirror symmetry for toric varieties*, Geometry and analysis. No. 2, Adv. Lect. Math. (ALM), vol. 18, Int. Press, Somerville, MA, 2011, pp. 3–37. MR 2882439
- [FLTZ12] ———, *T-duality and homological mirror symmetry for toric varieties*, Adv. Math. **229** (2012), no. 3, 1875–1911. MR 2871160 (2012m:14075)
- [Fuk05] Kenji Fukaya, *Multivalued Morse theory, asymptotic analysis and mirror symmetry*, Graphs and patterns in mathematics and theoretical physics, Proc. Sympos. Pure Math., vol. 73, Amer. Math. Soc., Providence, RI, 2005, pp. 205–278. MR 2131017 (2006a:53100)
- [GS11] Mark Gross and Bernd Siebert, *From real affine geometry to complex geometry*, Ann. of Math. (2) **174** (2011), no. 3, 1301–1428. MR 2846484
- [Hit01] Nigel Hitchin, *Lectures on special Lagrangian submanifolds*, Winter School on Mirror Symmetry, Vector Bundles and Lagrangian Submanifolds (Cambridge, MA, 1999), AMS/IP Stud. Adv. Math., vol. 23, Amer. Math. Soc., Providence, RI, 2001, pp. 151–182. MR 1876068 (2003f:53086)
- [IU] Akira Ishii and Kazushi Ueda, *Dimer models and exceptional collections*, arXiv:0911.4529.
- [Kon95] Maxim Kontsevich, *Homological algebra of mirror symmetry*, Proceedings of the International Congress of Mathematicians, Vol. 1, 2 (Zürich, 1994) (Basel), Birkhäuser, 1995, pp. 120–139. MR MR1403918 (97f:32040)
- [Kon98] ———, *Lectures at ENS Paris, spring 1998*, set of notes taken by J. Bellaïche, J.-F. Dat, I. Martin, G. Rachinet and H. Randriambololona, 1998.
- [KS06a] Maxim Kontsevich and Yan Soibelman, *Affine structures and non-Archimedean analytic spaces*, The unity of mathematics, Progr. Math., vol. 244, Birkhäuser Boston, Boston, MA, 2006, pp. 321–385. MR MR2181810
- [KS06b] ———, *Notes on A_∞ algebras, A_∞ categories and non-commutative geometry. I*, arXiv:math/0606241, 2006.
- [KV00] M. Kapranov and E. Vasserot, *Kleinian singularities, derived categories and Hall algebras*, Math. Ann. **316** (2000), no. 3, 565–576. MR MR1752785 (2001h:14012)
- [LYZ00] Naichung Conan Leung, Shing-Tung Yau, and Eric Zaslow, *From special Lagrangian to Hermitian-Yang-Mills via Fourier-Mukai transform*, Adv. Theor. Math. Phys. **4** (2000), no. 6, 1319–1341. MR 1894858 (2003b:53053)

- [McL09] Mark McLean, *Lefschetz fibrations and symplectic homology*, Geom. Topol. **13** (2009), no. 4, 1877–1944. MR 2497314 (2011d:53224)
- [Pas] James Pascaleff, *Floer cohomology in the mirror of the projective plane and a binodal cubic curve*, arXiv:1109.3255.
- [Ric89] Jeremy Rickard, *Morita theory for derived categories*, J. London Math. Soc. (2) **39** (1989), no. 3, 436–456. MR MR1002456 (91b:18012)
- [Sei08a] Paul Seidel, *A_∞ -subalgebras and natural transformations*, Homology, Homotopy Appl. **10** (2008), no. 2, 83–114. MR 2426130 (2010k:53154)
- [Sei08b] ———, *Fukaya categories and Picard-Lefschetz theory*, Zurich Lectures in Advanced Mathematics, European Mathematical Society (EMS), Zürich, 2008. MR MR2441780
- [Sei09] ———, *Symplectic homology as Hochschild homology*, Algebraic geometry—Seattle 2005. Part 1, Proc. Sympos. Pure Math., vol. 80, Amer. Math. Soc., Providence, RI, 2009, pp. 415–434. MR 2483942 (2010c:53129)
- [Sei10] ———, *Suspending Lefschetz fibrations, with an application to local mirror symmetry*, Comm. Math. Phys. **297** (2010), no. 2, 515–528. MR 2651908
- [SYZ96] Andrew Strominger, Shing-Tung Yau, and Eric Zaslow, *Mirror symmetry is T-duality*, Nuclear Phys. B **479** (1996), no. 1-2, 243–259. MR MR1429831 (97j:32022)

Kwokwai Chan

Department of Mathematics, The Chinese University of Hong Kong, Shatin, Hong Kong

e-mail address : kwchan@math.cuhk.edu.hk

Kazushi Ueda

Department of Mathematics, Graduate School of Science, Osaka University, Machikaneyama 1-1, Toyonaka, Osaka, 560-0043, Japan.

e-mail address : kazushi@math.sci.osaka-u.ac.jp